

242 Type Q

Male and Female VIP Toilets

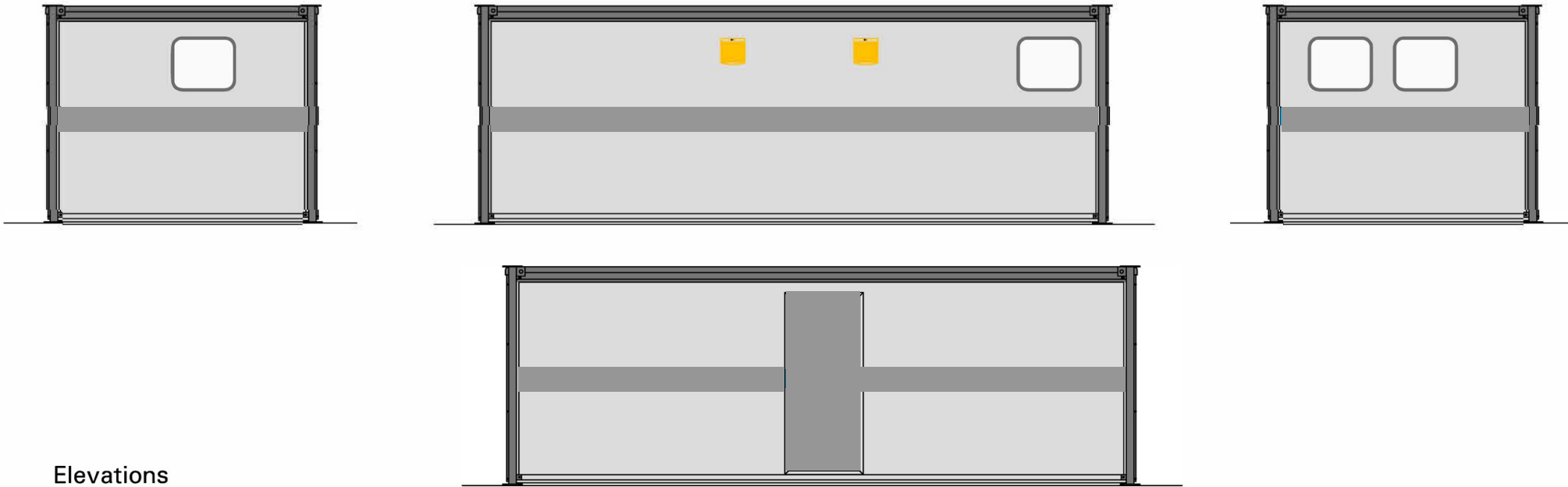

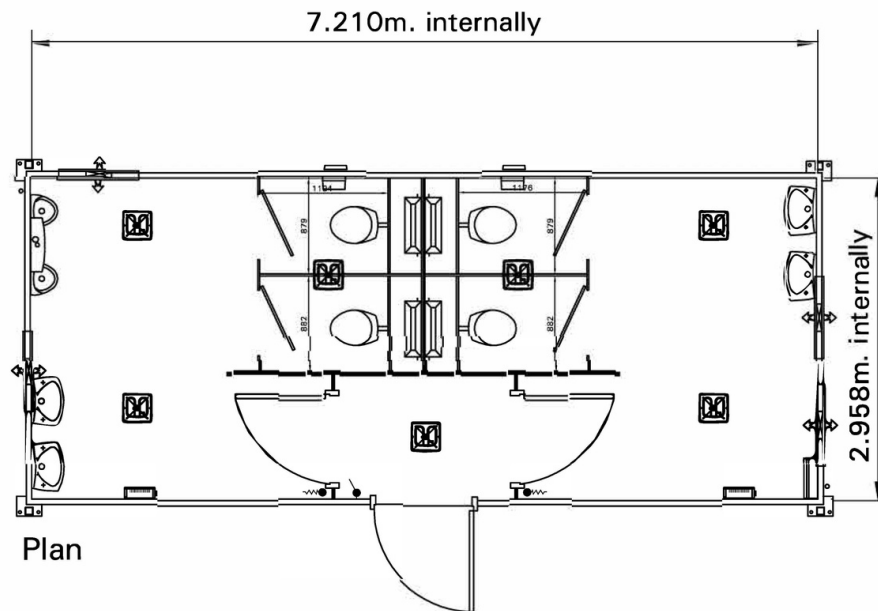









Elevations



Plan

LEGEND

-  LIGHT SWITCH (ONE WAY)
-  CEILING MOUNTED PULL SWITCH
-  CONSORT 2KW HIGH LEVEL FAN HEATER C/W FUSED SPUR
-  150MM GX6T VENT AXIA WALL MOUNTED EXTRACT FAN
-  FROST STAT C/W GUARD
-  3 POLE FAN ISOLATOR SWITCH
-  CROMPTON 1500MM BATTEN FITTING C/W OPAL DIFFUSER
-  25 LITRE ELSON PEARL WATER HEATER
-  50 LITRE ELSON PEARL WATER HEATER
-  3KW REDRING OVERSINK WATER HEATER